

# A2000

## Multifunctional Power Meter

3-348-981-03

19/7.06



<b>1</b>	<b>Application .....</b>	<b>4</b>
<b>2</b>	<b>Instrument Description .....</b>	<b>4</b>
2.1	Instrument Overview .....	4
2.2	Inputs, Outputs and Interfaces .....	5
2.3	Available Measurement Data .....	8
2.4	Possible A2000 Parameter Settings .....	10
2.5	Factory Default Instrument Parameters .....	12
<b>3</b>	<b>Operating the A2000 .....</b>	<b>13</b>
3.1	Control Panel .....	13
3.2	Response After Auxiliary Power is Switched On .....	13
3.3	Menu Display for Measurements in 4-Wire Systems .....	14
3.4	Menu Display for Measurements in 3-Wire Systems .....	16
3.5	Error Messages .....	18
<b>4</b>	<b>Configuring the A2000 .....</b>	<b>19</b>
4.1	Configuring the Limit Value Relays .....	20
4.2	Adjustment of Display Brightness and Filter .....	22
4.3	Measurement Inputs, Configuring the Synchronizing Input .....	24
4.4	Configuring the Analog Outputs (not with Profibus-DP) .....	26
4.5	Configuring the S0 Pulse Outputs .....	27
4.6	Data Logger Display and Configuration .....	28
4.7	Configuring the Energy Meter Mode/Low Tariff .....	33
4.8	Interface Configuration .....	34
4.9	Uploading and Deleting Parameters, Setting the Clock .....	36

<b>5</b>	<b>Electrical Connections and Circuits</b> .....	<b>38</b>
<b>6</b>	<b>Interface Description</b> .....	<b>41</b>
6.1	General .....	42
6.2	Communications Protocol .....	42
<b>7</b>	<b>Dimensional Drawing</b> .....	<b>43</b>
<b>8</b>	<b>Technical Data</b> .....	<b>44</b>
<b>9</b>	<b>Maintenance – Device Return and Environmentally Sound Disposal</b> .....	<b>46</b>
<b>10</b>	<b>Repair and Replacement Parts Service</b> <b>DKD Calibration Lab</b> <b>and Rental Instrument Service</b> .....	<b>47</b>
<b>11</b>	<b>Product Support</b> .....	<b>47</b>

## 1 Application

The A2000 measuring instrument is used for the analysis and monitoring of 3-phase current systems. It can be operated with internal transformers in 3-phase current systems of up to 5 A and 500 V nominal voltage, and can perform measurements in medium-voltage systems in combination with external current and voltage transformers.

The A2000 acquires voltages, current, frequency and phase displacement in 3 and 4-wire systems. It calculates active, reactive and apparent power, active and reactive energy, as well as the power factor for the individual phases based upon these values.

An FFT (= Fast Fourier Transformation) is performed on the basis of the currents and phase voltages and the harmonic waves are determined up to the 15<sup>th</sup> harmonic. For the phase voltages, the harmonic distortions of the individual harmonics are indicated as well as the total harmonic distortion, for the currents, the respective RMS values are indicated.

Transformation ratios can be entered to the instrument, which means that all primary measurement data can be displayed directly at the A2000. Maximum values are stored to memory for every measured or calculated quantity. If limit values are exceeded, corrective action can be triggered via relay outputs. Energy meters, recorders, data loggers and control loops can be connected to the digital and analog outputs. The instrument can be integrated into a field bus system or a LON network with the communications interfaces, or its parameters can be configured with a PC.

## 2 Instrument Description

### 2.1 Instrument Overview

#### Inputs

3 ea.  
Voltage Inputs

3 ea.  
Current Inputs

1 ea.  
Synchronizing Input

#### Communication Interfaces

#### A2000

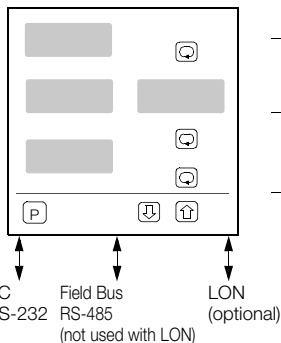

## 2.2 Inputs, Outputs and Interfaces

### Current Inputs

All current inputs are isolated from one another. If measurements are performed with external transformers, their primary and secondary current values must be entered, in order to enable direct display of current values. Switching between the two meas. ranges (1 A and 5 A) is accomplished via software.

Connection with 3 current transformers in 3/4-wire systems (4L)

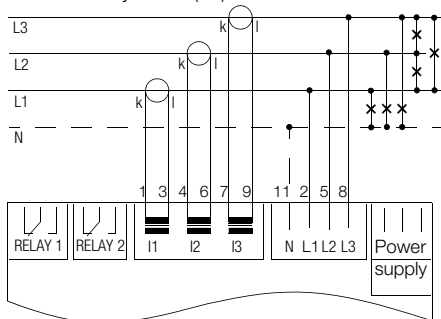

Connection with 2 current transformers in 3-wire systems (3L)

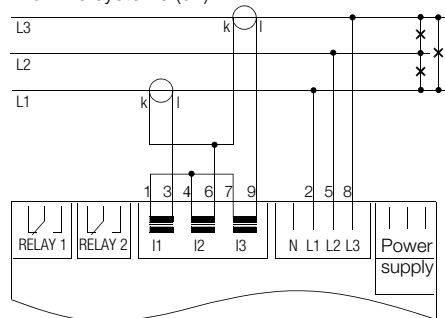

Connection with 1 current transformer in 4-wire systems (balanced load) (3L-1)

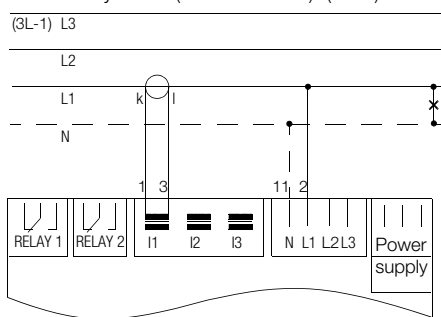

Connection with 1 current transformer in 3-wire systems (balanced load) (3L-1)

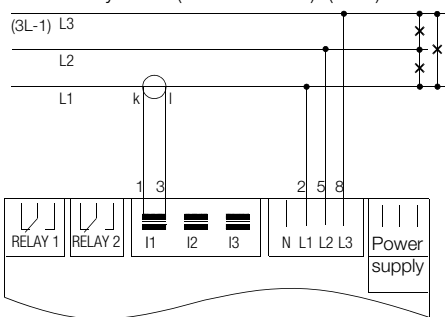

Connection with 1 current transformer  
in 3-wire systems (balanced load) (3L13)

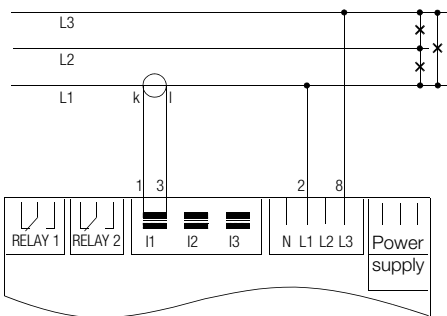

For this connection type the accuracy values for the measurement of power, energy and power factor are only observed in the case of low-distortion tension. The setting „Compensating reactive power“ is not possible.

Connection with 3 current transformers  
in 4-wire systems (Open Y) (4L13)

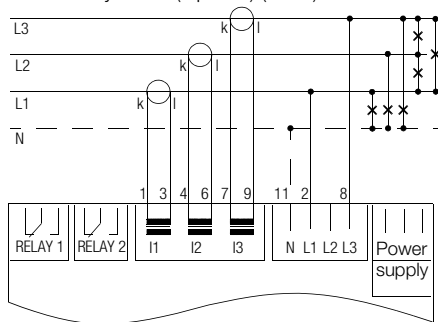

## Voltage Inputs

Each voltage measurement input is provided with a safety impedance (incl. the N conductor). Measurements within 3-phase systems of up to 500 V are possible without the use of external transformers.

## Mains Supply Power

Mains supply power must correspond to the specified values indicated on the serial plate. Correct connection is absolutely essential!

## Synchronizing Input

The synchronizing input is used to select the interval for calculation of the consumption value. An external, potential-free contact must be used to drive this input. However, synchronization can also be internally controlled with the software. Alternatively, a switch-over between low tariff and high tariff is possible with the synchronizing input (see chapter 4.7 on page 33).

## Relay Outputs

Limit values can be monitored for every measured or calculated quantity. These limit values can be assigned to the relay outputs.

## Pulse Outputs

The values for measured reactive and active energy can be read out at the pulse outputs in the form of standard S0 pulses for the driving of electromechanical counting mechanisms.

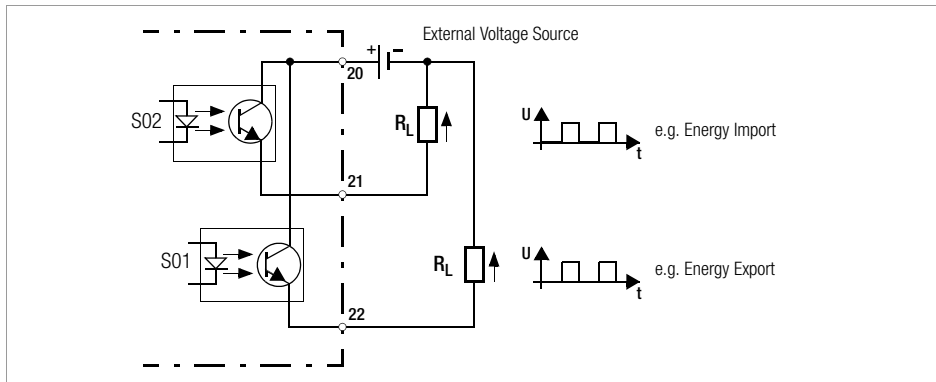

## Analog Outputs

Each measured or calculated quantity can be assigned to one of the analog outputs. Exception: FFT-values, which can only be read out via the RS-232 and RS-488 interfaces. This allows for the logging or driving of secondary control loops. The outputs can be configured as voltage or current outputs with the help of the DIP switches.

## Communications Interfaces

The A2000 is provided with RS232 and RS485 interfaces as standard equipment. The RS485 interface is not included with the LON model due to space limitations.

The **RS232 interface** allows for the transmission of measurement values from the A2000 to a PC, as well as external instrument configuration. The chapter entitled "Interface Description" on page 41 provides detailed information regarding the generation of user specific programs. The **RS485** field bus interface allows for the interconnection of up to 32 instruments.

## 2.3 Available Measurement Data

	Individual Phases				Collective Values				
	U1 ... U3		U1 <sub>max</sub> ... U3 <sub>max</sub>		U <sub>Σ</sub> <sup>4)</sup>		U <sub>Σ max</sub> <sup>5)</sup>		
Phase Voltages	U1 ... U3		U1 <sub>max</sub> ... U3 <sub>max</sub>		U <sub>Σ</sub> <sup>4)</sup>		U <sub>Σ max</sub> <sup>5)</sup>		
Delta Voltages	U12, U23, U31		U12 <sub>max</sub> ... U31 <sub>max</sub>		U <sub>Δavg</sub> <sup>4)</sup>		U <sub>Δavg max</sub> <sup>5)</sup>		
Phase Current	I1 ... I3		I1 <sub>max</sub> ... I3 <sub>max</sub>		I <sub>Σ</sub> <sup>4)</sup>		I <sub>Σ max</sub> <sup>5)</sup>		
Averaged Phase Current	I1 <sub>avg</sub> ... I3 <sub>avg</sub>		I1 <sub>avg max</sub> ... I3 <sub>avg max</sub>		I <sub>avg</sub> <sup>4)</sup>		I <sub>avg Σ max</sub> <sup>5)</sup>		
Neutral Conductor current	In		In <sub>max</sub>		—		—		
Averaged Neutral Conductor Current	In <sub>avg</sub>		In <sub>avg max</sub>		—		—		
Line Frequency	—		—		f		—		
Active Power	P1 ... P3		P1 <sub>max</sub> ... P3 <sub>max</sub>		P <sub>Σ</sub>		P <sub>Σ max</sub>		
Reactive Power	Q1 ... Q3		Q1 <sub>max</sub> ... Q3 <sub>max</sub>		Q <sub>Σ</sub>		Q <sub>Σ max</sub>		
Apparent Power	S1 ... S3		S1 <sub>max</sub> ... S3 <sub>max</sub>		S <sub>Σ</sub>		S <sub>Σ max</sub>		
Power Factors	PF1 ... PF3		PF1 <sub>min</sub> ... PF3 <sub>min</sub>		PF <sub>Σ</sub>		PF <sub>Σ min</sub>		
Energy Mode	L123 <sup>1)</sup>	LTHT <sup>2)</sup>	L123 <sup>1)</sup>	LTHT <sup>2)</sup>	L123 <sup>1)</sup>	LTHT <sup>2)</sup>		L123 <sup>1)</sup>	LTHT <sup>2)</sup>
Active Energy	E <sub>P1</sub> ... E <sub>P3</sub>	—	—	—	E <sub>PΣ</sub>	E <sub>PΣ L-</sub> , E <sub>PΣ L+</sub> E <sub>PΣ H-</sub> , E <sub>PΣ H+</sub> <sup>3)</sup>		—	—
Reactive Energy	E <sub>Q1</sub> ... E <sub>Q3</sub>	—	—	—	E <sub>QΣ</sub>	E <sub>QΣ L-</sub> , E <sub>QΣ L+</sub> E <sub>QΣ H-</sub> , E <sub>QΣ H+</sub> <sup>3)</sup>		—	—
Intervalic Active Energy	—		—		P <sub>int Σ</sub>		P <sub>int Σ max</sub>		
Interv. Reactive Energy	—		—		Q <sub>int Σ</sub>		Q <sub>int Σ max</sub>		
Interv. Apparent Energy	—		—		S <sub>int Σ</sub>		S <sub>int Σ max</sub>		
THD, 1 <sup>st</sup> ... 15 <sup>th</sup> harmon.	U1h ... U3h, I1h ... I3h		U1hmax ... U3hmax, I1hmax ... I3hmax		—		—		

1) L123 = individual phases L1, L2, L3

2) LTHT = low tariff (LT) high tariff (HT)

3) L = low tariff, H = high tariff, + = import, - = export

4) only via interface and as a source for relay and analog output

5) only via interface

- The determination of measured and calculated quantities is performed in accordance with DIN 40110 part 1,2 4.96 (non-sinusoidal quantities).
- PEN conductor current is not taken into consideration for the calculation of collective phase current and collective apparent power.
- The averaging of currents I1<sub>avg</sub> ... I3<sub>avg</sub>, In<sub>avg</sub> is performed in the same manner as with a bimetallic indicator, with a setting time of approx. 10 min relative to 99% of the final value.



## Display of Reactive Power

$d, n$  = calculation of reactive power per DIN 40110 without + or - sign

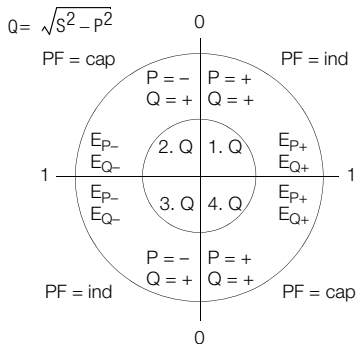

$S, \bar{U}_n$  = calculation of reactive power with + or -

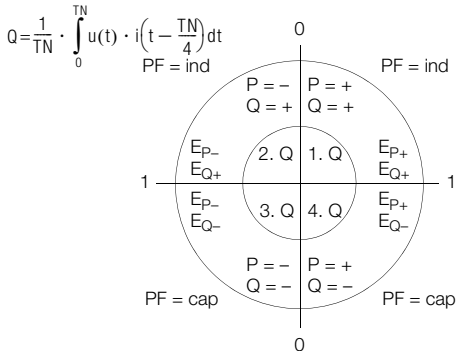

$\bar{U}_n \bar{I}_P$  = compensating reactive power  
(reactive power is only produced if current and voltage have different + or - signs)

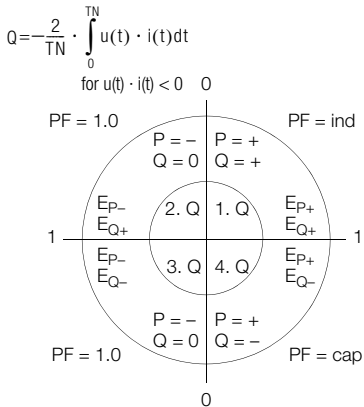

## Calculation of Collective Values

$$U_{\Delta \text{avg}} = (U_{12} + U_{23} + U_{31}) / 3$$

$$U_{\Sigma} = \sqrt{U_1^2 + U_2^2 + U_3^2}$$

$$I_{\Sigma} = \sqrt{I_1^2 + I_2^2 + I_3^2} \text{ (without } I_N)$$

$$S_{\Sigma} = U_{\Sigma} \cdot I_{\Sigma}$$

$$P_{\Sigma} = P_1 + P_2 + P_3$$

$$Q_{\Sigma} = \sqrt{S_{\Sigma}^2 - P_{\Sigma}^2} \text{ (per DIN)}$$

$$Q_{\Sigma} = Q_1 + Q_2 + Q_3 \text{ (others)}$$

$$\text{PF}_{\Sigma} = P_{\Sigma} / S_{\Sigma}$$

## 2.4 Possible A2000 Parameter Settings

Inputs 4 or 3-Wire Connection	Primary Transformer Phase Conductor	Secondary Transformer Phase Conductor	Transformer Primary Current	Transformer Secondary Current	Synchronization Pulse
	100 V ... 750 kV	100 V ... 500 V	1 A ... 150 kA	1 A, 5 A	external or internal: 1 ... 60 minutes
Relay 1, 2 Max, Min	Source	Limit Value	Hysteresis	Delay	Alarm Memory
	1) 4)	2)	0 ... 9999 Digit	0 ... 30 min	off, on
Analog Outputs 1 ... 4	Source	Output	Start Source	End Source	
	1) 3)	0 ... 20 mA 4 ... 20 mA -20 ... +20 mA	2)	2)	
Pulse Outputs S01, S02	Source	Energy Type	Energy Direction	Pulse Rate	Tariff
	L1, L2, L3, $\Sigma$	Active, Reactive Energy	Import, Export	1 ... 5000 pulses/kWh (MWh) 1 ... 5000 pulses/kVarh (MVarh)	High, low tariff
Display	Brightness 0 ... 7	Filter 0 ... 30 s			
Interfaces RS-232, RS-485	Address	Baud Rate		Parity	Protocol
	0 ... 254	1200, 2400, 4800, 9600, 19200		Even, odd, space, no	E244, 870, Mod1, Mod2
Energy Meter	Mode			Switchover high/low tariff	
	L123 / LTHT 5)			Clock / Synchr. input	
Reactive Power	per DIN / with +/- sign / for Compensation				

1) Possible sources (see below)

2) Limits are dependent upon the selected transformation ratio at the voltage or current transformer

3) Interval -1 applies to  $P_{int}$ ,  $Q_{int}$  or  $S_{int}$  (for recording max. values)

4) Interval 0 applies to  $P_{int}$ ,  $Q_{int}$  or  $S_{int}$  (current shutdown interval for shutdown options)

5) L123 = individual phases L1, L2, L3; LTHT = low tariff high tariff

## Possible Parameter Setting, Data Logger

Trigger: relay 1, relay 2, both, off	Pretrigger: 0%, 25%, 50%, 75%	Disable Trigger: external (synchronizing input), off
Sampling Time: 0,3 s, 0,6 s, 1 s, 2 s, 5 s, 10 s, 15 s, 30 s, 1 min, 2 min, 5 min, 10 min, 15 min, 30 min	Storetime: 1 min, 2 min, 5 min, 10 min, 15 min, 30 min, 1 h, 2 h, 4 h, 8 h, 12 h, 1 day, 2 day, 4 day	Storemode: cyclic, once
Trace 1 ... 12: Source, off		

## Possible Sources for Relays, Analog Outputs and Logger

	U $\Delta$	U $\nabla$	I	I <sub>avg</sub>	P	Q	S	PF	Fre- quency	P <sub>int</sub>	Q <sub>int</sub>	S <sub>int</sub>	Ext
Source	U12	U1	I1	I1 <sub>avg</sub>	P1	Q1	S1	PF1	f	P <sub>intΣ</sub>	Q <sub>intΣ</sub>	S <sub>intΣ</sub>	Actu- tion via inter- face (not for logger)
	U23	U2	I2	I2 <sub>avg</sub>	P2	Q2	S2	PF2					
	U31	U3	I3	I3 <sub>avg</sub>	P3	Q3	S3	PF3					
	U $\Delta$ <sub>mean</sub>	U $\Sigma$	I $\Sigma$	I $\Sigma$ <sub>avg</sub>	P $\Sigma$	Q $\Sigma$	S $\Sigma$	PF $\Sigma$					
	—	—	I <sub>n</sub>	I <sub>n</sub> <sub>avg</sub>	—	—	—	—					
for all Phases (only for Relays)													

## Additional Sources for Logger

	EP	EQ	I hd	U hd
Source	EP1 / EP $\Sigma_{L-}$	EQ1 / EQ $\Sigma_{L-}$	I thd	U thd
	EP2 / EP $\Sigma_{L+}$	EQ2 / EQ $\Sigma_{L+}$	I 1.hd	U 1.hd
	EP3 / EP $\Sigma_{H-}$	EQ3 / EQ $\Sigma_{H-}$	:	:
	EP $\Sigma$ / EP $\Sigma_{H+}$	EQ $\Sigma$ / EQ $\Sigma_{H+}$	I 15.hd	U 15.hd

## 2.5 Factory Default Instrument Parameters

Inputs	Primary Transformer Phase Conductor	Secondary Transformer Phase Conductor	Transformer Primary Current	Transformer Secondary Current	Synchronization Pulse
4-Wire	500 V	500 V	5 A	5 A	Internal, 15 minutes
Relay 1	Source	Limit Value	Contact Type	Hysteresis, Delay	Alarm Memory
	I1	5 A	Max	0	off
Relay 2	U1	240 V	Max	0	off
	Source	Output	Start Source	End Source	
Analog Output 1	PΣ	4 ... 20 mA	0 W	2000 W	
Analog Output 2	QΣ	4 ... 20 mA	0 VAr	1000 VAr	
Analog Output 3	I2	4 ... 20 mA	0 A	5 A	
Analog Output 4	U2	4 ... 20 mA	0 V	250 V	
	Source	Energy Type	Energy Direction	Pulse Rate	Tariff
S01	EPΣ	Active Energy	Import	10 pulses/kWh	High tariff
S02	EPΣ	Active Energy	Export	10 pulses/kWh	High tariff
Display	Brightness 5	Filter 0			
RS-232, RS-485	Baud Rate 9600	Address 250	Parity Even	Protocol E244	
Energy Meter	Mode LTHT				
Reactive Power	per DIN				

### Factory Default Data Logger Parameters

Trigger: off	Pretrigger: 50%	disable Trigger: off
Sampling time: 0.3 s	Storetime: 1 min	Storemode: once
Trace 1 ... 12: all off		

This table applies to the setting: "Set – set default".

### 3 Operating the A2000

#### 3.1 Control Panel

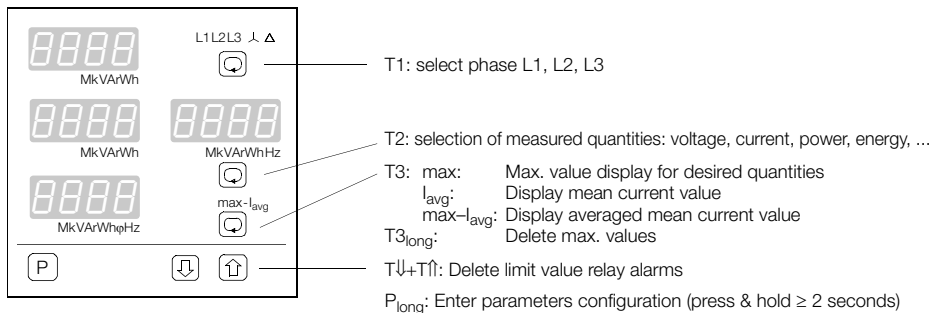

#### 3.2 Response After Auxiliary Power is Switched On

Segment Test  $\rightarrow$  Display of phase sequence and connected phases  $\rightarrow$  Display Menu

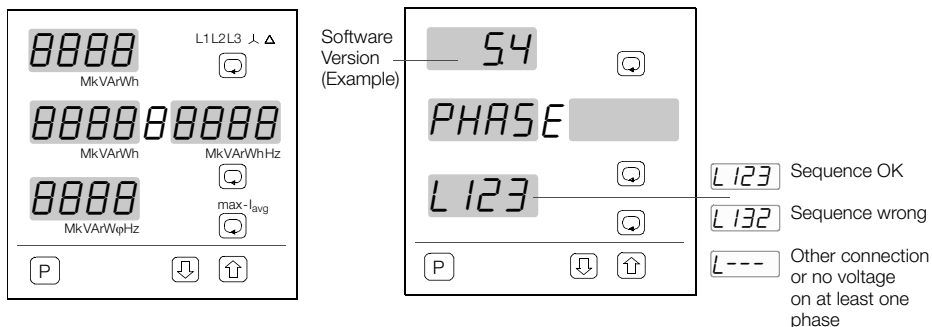

The operating mode displayed prior to shutdown is displayed when the instrument is switched on again.

### 3.3 Menu Display for Measurements in 4-Wire Systems

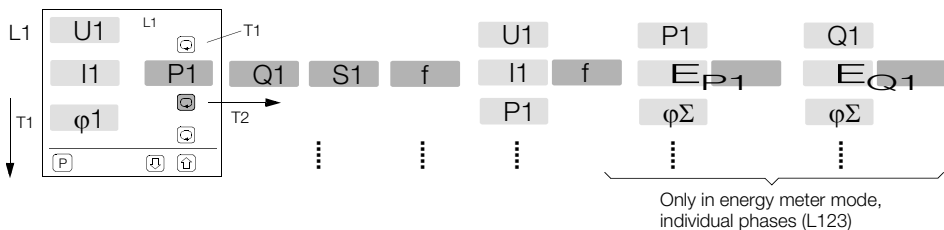

L2 See diagram L1 for L2 values

L3 See diagram L1 for L3 values

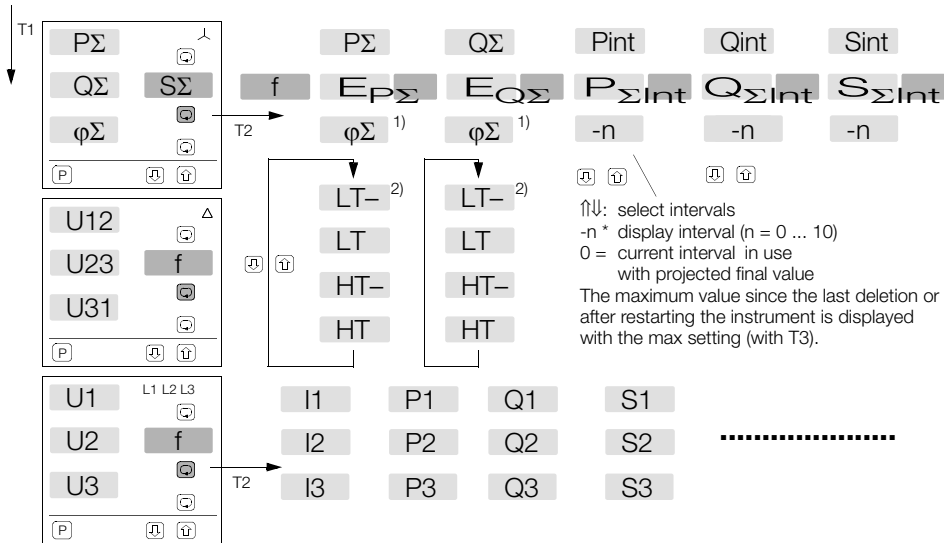

If a rotating field is established at the U or I inputs of the A2000, the neutral conductor current is displayed instead of the frequency.

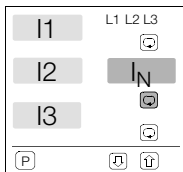

L1, L2, L3,  $\Delta$ ,  $\Delta$  and L123 comprise 6 display groups. If a given group is exited, the current display mode is stored to memory and is re-initialized when the group is queried again.

- 1) in energy meter mode L123
- 2) in energy meter mode LTHT

- LT-** Low Tariff Export
- LT** Low Tariff Import
- HT-** High Tariff Export
- HT** High Tariff Import

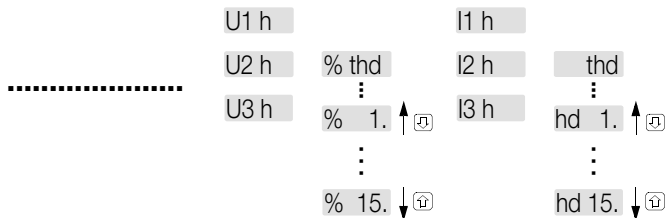

When displaying the maximum values of the harmonic, press key **P** to indicate the time and date when the respective maximum value occurred.  
(Function only available for version with data logger)

### 3.4 Menu Display for Measurements in 3-Wire Systems

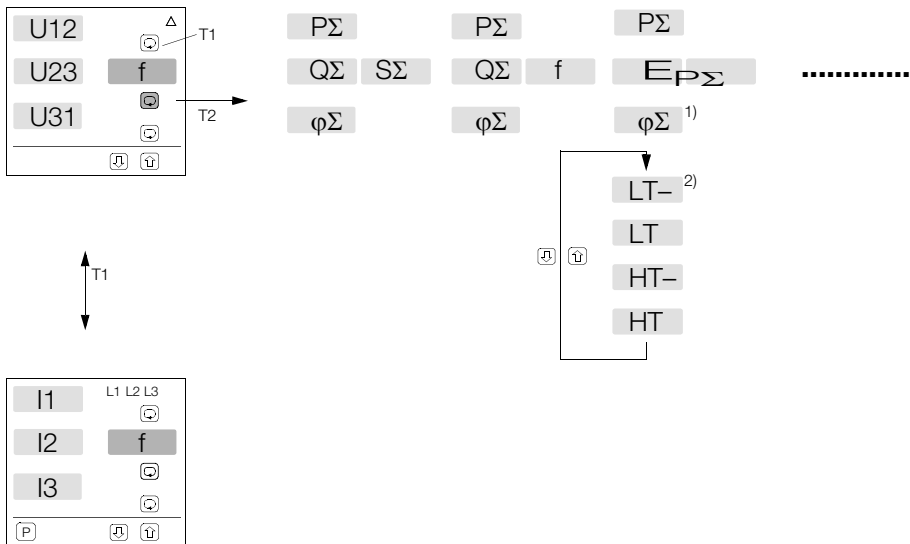

If a rotating field is established at the U or I inputs of the A2000, the neutral conductor current is displayed instead of the frequency.

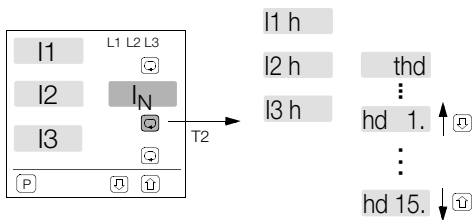

When displaying the maximum values of the harmonic, press key [P] to indicate the time and date when the respective maximum value occurred. (Function only available for version with data logger)



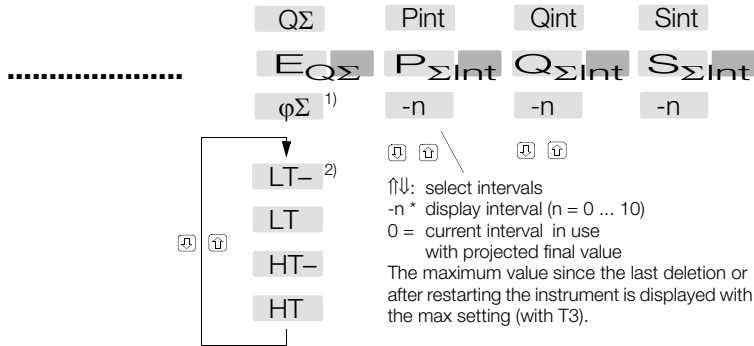

1) in energy meter mode L123

2) in energy meter mode LHHT

$LT-$  Low Tariff Export

$LT$  Low Tariff Import

$HT-$  High Tariff Export

$HT$  High Tariff Import

### 3.5 Error Messages

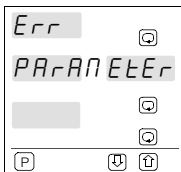

Parameters Error

One or more parameters have been irreparably corrupted.

Remedy: Enter **[P]**<sub>long</sub> configurations menu.

SET USER restores the user parameter set which has been stored to memory.

SET DEFAULT restores all factory default parameters.



Error at Analog Component

Check the measuring voltages with a multimeter in the direct current measuring range to see whether or not they demonstrate a direct current component of greater than 6 V.

If this is not the case, the analog component is defective. Send the instrument to our service department.



Calibration Error

The calibration values in the EEPROM have been corrupted.

Send the instrument to our service department.

## 4 Configuring the A2000

Configuration changes are only possible if the 'LOCK' DIP switch is in the 'off' position.

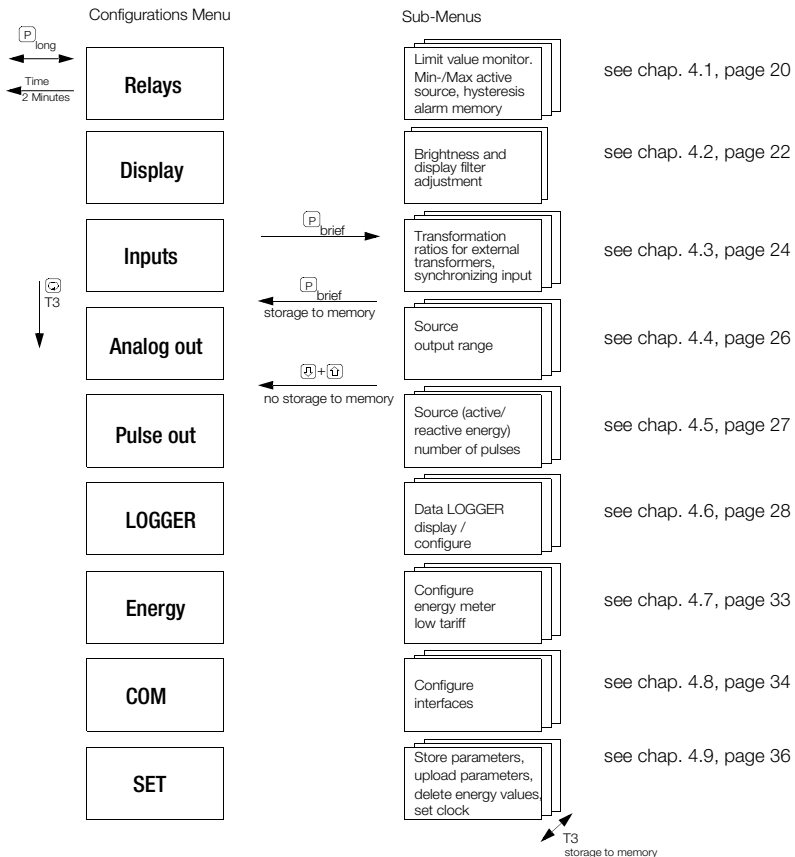

## 4.1 Configuring the Limit Value Relays

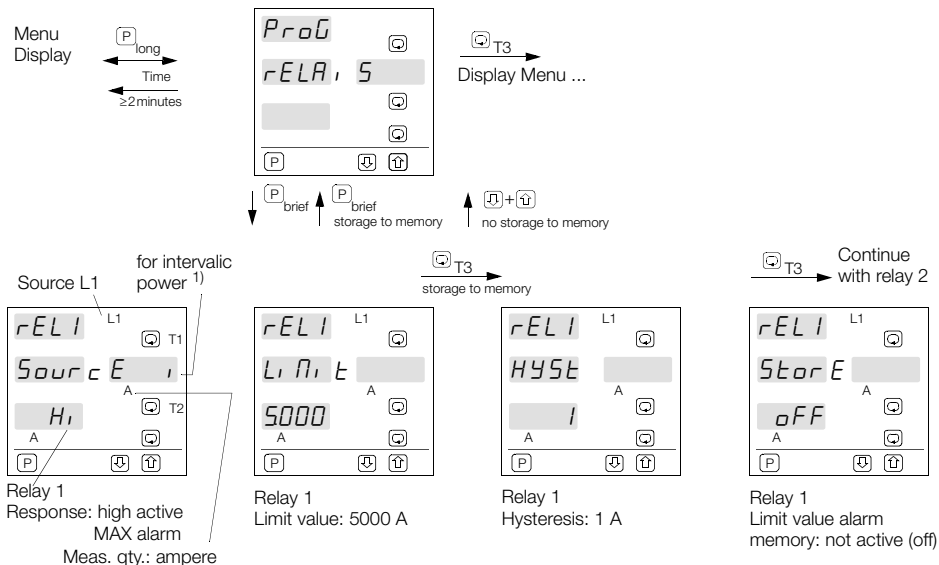

### T1: Source Selection

L1, L2, L3 Individual Phases  
 L12, L23, L13 Phase-to-phase voltage  
 $\downarrow$  Collective Values  
 L123 Neutral Conductor Current  
 L123  $\downarrow$  for all Phases

### T2: Meas. Quantity Selection

$V_{\Delta}$ ,  $V$ , A,  $A_{AVG}$ , W,  
 VAr, VA,  $\phi$ , Hz, Wi,  
 VArI, VAi, external

### $\text{T}+\text{U}$ : Value Settings

Limit values: high / low active

### $\text{T}+\text{U}$ : Value Settings

Hz: 40.00 ... 70.00  
 V, A: 1 ... 9999 <sup>2)</sup>  
 W, ...  
 -9999 ... 9999 <sup>2)</sup>  
 PF: 0.01c ... 0.99c ...  
 ... 1.00 ...  
 0.99L ... 0.01L

### $\text{T}+\text{U}$ : Value Settings

0, 1, ... 9999 Digits

### $\text{T}+\text{U}$ : Value Settings

Alarm memory  
 on = active  
 off = not active

In the display mode,  
 a stored alarm is  
 (simultaneously) deleted  
 with  $\text{T}+\text{U}$ .

<sup>1)</sup> The source is relative to the current (-0) interval value ( $P_{\Sigma\text{int}}$ ,  $Q_{\Sigma\text{int}}$ ,  $S_{\Sigma\text{int}}$ ) for intervalic power

<sup>2)</sup> Decimal point depending upon settings of the transformation ratio

Example: Limit value relay 2, but with other quantities and values.

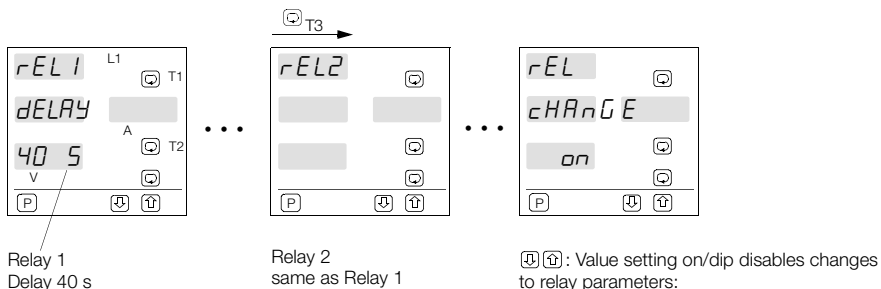

: Value setting

0

1, 2, 3, 5, 8, 15, 25, 40 s

1, 2, 3, 5, 8, 15, 30 min

Changes to relay parameter settings can be either disabled or enabled with the "LOCK" DIP switch. For example:

1. Enable changes to all parameters:  
'LOCK' = position OFF, rel change = dip or on
2. Disable changes to all parameters:  
'LOCK' = position on, rel change = dip
3. Disable changes to all parameters except for relay parameters:  
'LOCK' = position on and rel change = on

rel change can only be set to "on" if "LOCK" has previously been set to OFF.

## 4.2 Adjustment of Display Brightness and Filter

### Adjusting display brightness

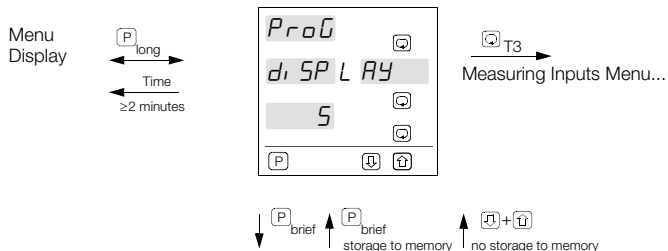

### Adjusting display filter

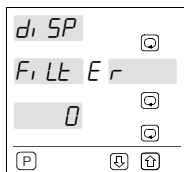

---

### Parameters for display brightness

**T** **T+**: Adjustment of values

The values are adopted immediately upon entry.

0 ... 7

For permanent setting, however, storage to memory is recommended.

0 minimum brightness

7 maximum brightness

---

## Parameters for display filter

 : Adjustment of values

Time constant  $\tau$  in s

0 ... 30

0 no filter effect

30 maximum filter effect

The display filter is a software filter which acts as a lowpass function with the time constant  $\tau$ .

A time constant between 0 and 30 s can be set to stabilize the display in the event of fluctuating input signals or interfering signals. If an input signal soars abruptly, the displayed value adjusts only gradually to the actual value, in line with the selected time constant. After  $5 \tau$  almost 100% of the input signal are displayed.

Set the time constant to 0, if the changes are to be displayed immediately and in an unfiltered manner.

### 4.3 Measurement Inputs, Configuring the Synchronizing Input

Menu  
Display

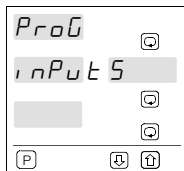

T3  
Analog Output Menu ...



3-Wire Connection

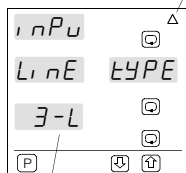

3-wire system  
is connected

T3  
storage to memory

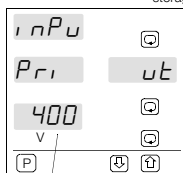

Input transformer  
primary voltage:  
400 V phase-to-phase

T3

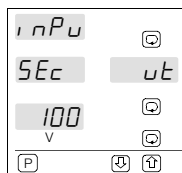

Input transformer  
secondary voltage:  
100 V phase-to-phase

: Value Settings

- 4L and display of  $\downarrow$  for 4-wire non-balanced load
- 3L and display of  $\Delta$  for 3-wire non-balanced load
- 3L-1 and display of  $\Delta$  for one current transformer
- 3L13 and display of  $\Delta$  for one current transformer and one phase-to-phase voltage
- 4L13 and display of  $\downarrow$  for 4-wire non-balanced load and open-Y connection (see chapter 2.2)

: Value Settings

- 100 V ... 750 kV
- 100V steps for  $U_t < 100\text{kV}$
- 1 kV steps for  $U_t \geq 100\text{kV}$

: Value Settings

- 100 V ... 500 V
- in 1 V steps



T3 →

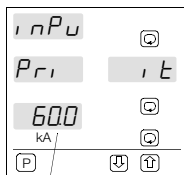

Input transformer primary current: 60.0 kA

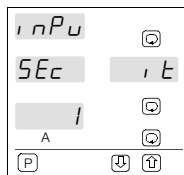

Input transformer secondary current: 1.00 A

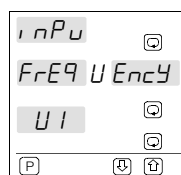

Line frequency synchronization

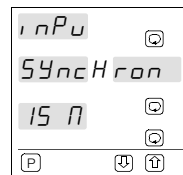

Synchronizing pulse every 15 minutes

**U I**: Value Settings

1 A ... 150 kA

5 A steps for  $I_1 < 5$  kA  
 50A steps for  $I_1 > 5$  kA  
 500A steps for  $I_1 > 50$  kA

**U I**: Value Settings

1 or 5 A

**U I**: Value Settings

**Auto** All phases, voltage and current are scanned.

**U I** Only voltage U1 is used.

**U I**: Value Settings

external, 1 ... 60 minutes

**E E T** ext. synchronizing pulse to synchronizing input, or internal with selection of interval from 1 to 60 min.

## 4.4 Configuring the Analog Outputs (not with Profibus-DP)

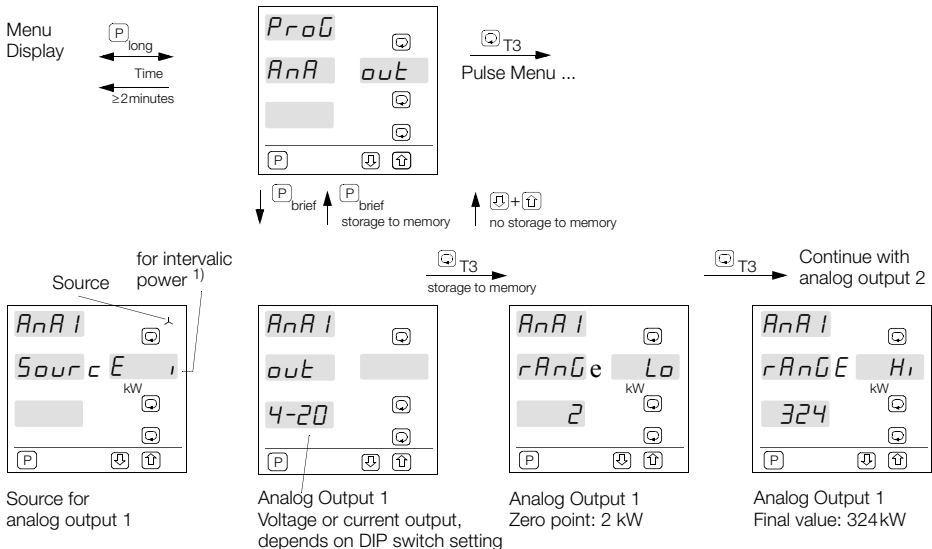

### T1: Source Selection

L1, L2, L3 Individual phases  
L12, L23, L13 Phase-to-phase voltage  
Collective Values  
L123 Neutral conductor current

### $\text{T}+\text{T}$ : Value Settings

4-20 = 2-10V or 4-20mA  
Output Quantities  
Display Volt mA  
0-20 0-10 0-20  
4-20 2-10 4-20  
2020  $\pm 10$   $\pm 20$

### $\text{T}+\text{T}$ : Value Settings

0 ... 9999  
for P:  
-999 ... 9999

### $\text{T}+\text{T}$ : Value Settings

0 ... 9999  
for P:  
-999 ... 9999

### T2: Meas. Quantity Selection

$V_{\Delta}$ , V, A,  $A_{AVG}$ , W,  
VAr, VA,  $\phi$ , Hz, Wi,  
VAri, VAI, external

DIP A1: U=on I=on  
I=off U=off

The appropriate DIP switches  
must be set correctly!

The same windows and values apply to analog output 2.  
Analog outputs 3 and 4 may also be optionally included.

<sup>1)</sup> The source is relative to the latest completed interval value ( $P_{\Sigma int}$ ,  $Q_{\Sigma int}$ ,  $S_{\Sigma int}$ ) for intervalic power

## 4.5 Configuring the S0 Pulse Outputs

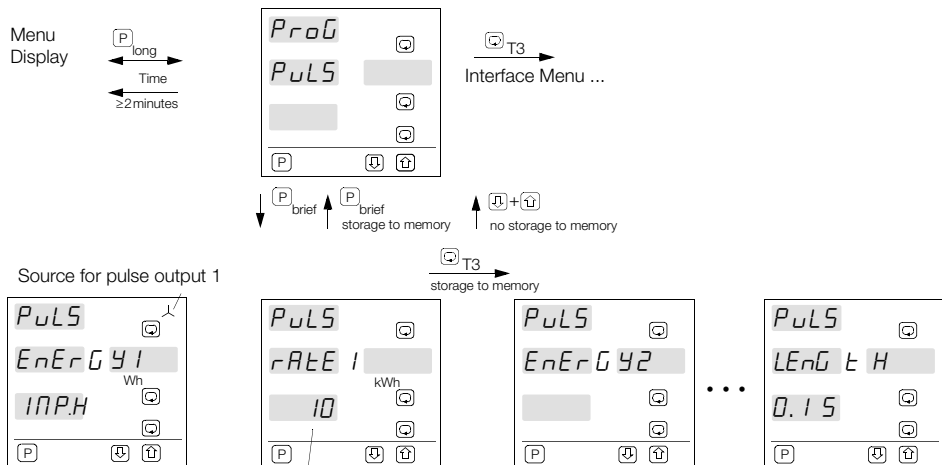

Source, pulse output 1:  
collective energy (4L)

Pulse output 1  
Pulse rate  
10 pulses / kWh

Pulse output 2:  
same as pulse output 1

Pulse outputs  
Pulse length  
0.1 s

T1: Source Selection  
L1, L2, L3, ↵

⏏ ⏏: Value Settings

⏏ ⏏: Value Settings

T2: Quantity Selection  
Active/reactive energy  
kWh, kVArh,  
Mwh, MVArh

1 ... 5000 pulses / kWh (MWh)  
or kVArh (MVArh)  
Resolution:  
1 pulse if rate < 1000  
10 pulses if rate ≥ 1000

0.1 s ... 0.8 s

⏏ ⏏: Value Settings

**INPL** = import, low tariff; **INPH** = import, high tariff,

Import energy from the system (positive sign)

**E3PL** = export, low tariff; **E3PH** = export, high tariff,

Export energy to the system (negative sign)

The import and export settings are without significance for reactive energy, which is always indicated with a positive value.

## 4.6 Data Logger Display and Configuration

### Display for Trigger Source Setting rel 1, rel 2, both

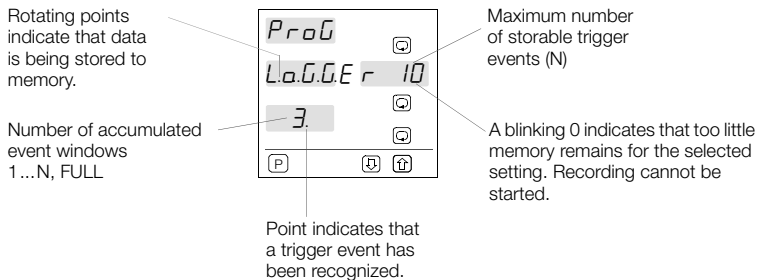

---

If the data logger is not recording, the display blinks alternately: Logger/stop

Attention:

If the real-time clock has stopped, the display blinks alternately: Logger/time date

Operation of the data logger is interrupted if:

- Memory is full and the memory mode is set to „once“
- If a data logger parameter is changed (display: Logger/stop)
- The data logger is started with long
- The data logger is stopped with long

**Attention: Memory is cleared when the data logger is started!**

## Display for parameter setting Trigger Source OFF

Rotating points indicate that data is being stored to memory.

0...99%, FULL  
(memory occupancy level)

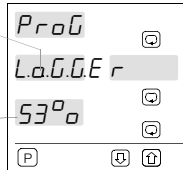

---

If the power supply is interrupted during a recording session, the A2000 supplements the outstanding samples after restarting the instrument:

- A value of „0“ is entered for all measured quantities, except for energies (last meter reading)
- If a trigger source has been selected, the beginning of power supply interruption is always considered to be a trigger.
- If the trigger source has been set to „OFF“, the beginning of power supply interruption is recorded in the time stamp of the last trigger. (Time stamp of the first trigger = start of recording)
- If power supply interruption takes longer than the remaining storage rate, the current window is completed and a new untriggered window is produced if a trigger source has been selected.
- 



In the case of trigger source „OFF“, cyclical memory mode and a power supply interruption which takes longer than the storage rate, the complete memory will be overwritten.

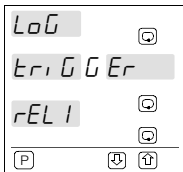
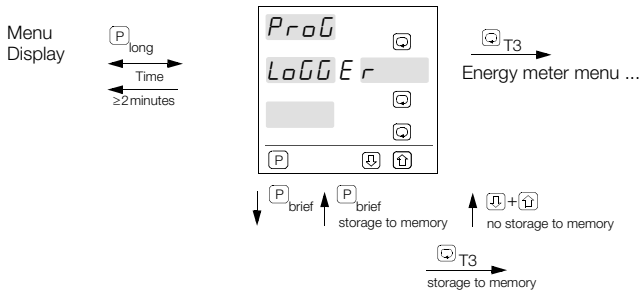

Trigger source setting

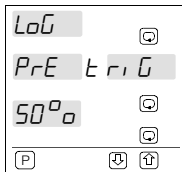

Trigger source setting

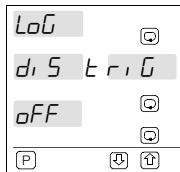

External trigger disabling when trigger source ≠ OFF

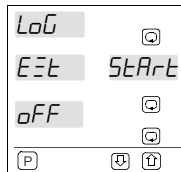

Data logger Start/Stop when trigger source ≠ OFF

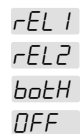

If the trigger source is set to OFF, data is recorded continuously to memory. For data logger an alarm memory is not relevant.

Triggering can be disabled via the synchronization input.

The data logger can be launched and stopped via the synchronization input. Start and Stop via keyboard are not possible in this case.

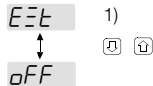

1) If the external input is used as a synchronizing input, no switching to external is possible. (Display: -no-)

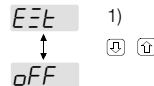

1) If the external input is used as a synchronizing input, no switching to external is possible. (Display: -no-)

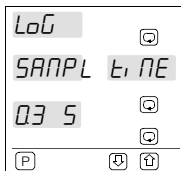

Sampling time

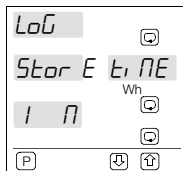

Storage rate

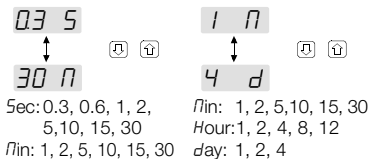

Sampling time  $T_{sa}$ , storage time  $T_{st}$  and number of traces  $\Sigma Tr$  result in a maximum number of storable trigger events  $N$  with a memory capacity of 128 kByte

$$N = (63000 \times T_{sa}) / (T_{st} \times \Sigma Tr)$$

(Round  $N$  up to whole number:  $N_{min} = 1$ ,  $N_{max} = 99$ )

If the display blinks when the value is selected, the memory is too small for the selected setting.

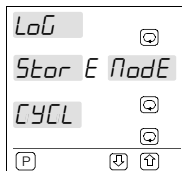

Memory is overwritten cyclically when full.

T3  
storage to memory

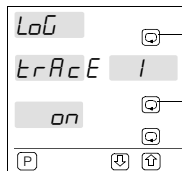

Selection of max. 12 quantities to be recorded

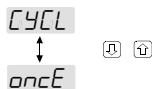
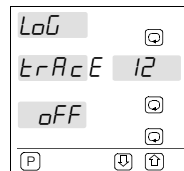

The data logger is stopped when memory is full.

#### T1: Source Selection

L1, L2, L3 Individual phases  
 L12, L23, L13 Phase-to phase voltage  
 ∩ Collective Values  
 L123 Neutral conductor current

#### T2: Meas. Quantity Selection

$V_{\Delta}$ ,  $V_i$ ,  $A$ ,  $A_{AVG}$ ,  $W$ ,  
 $VAR$ ,  $VA$ ,  $\phi$ ,  $Hz$ ,  $W_i$ ,  
 $VAR_i$ ,  $VA_i$ ,  $Wh$ ,  
 $VAR_h$ ,  $Ahd$ ,  $Vhd$ ,  $OFF$

The source is relative to the latest completed interval value for intervalic power ( $P_{\Sigma int}$ ,  $Q_{\Sigma int}$ ,  $S_{\Sigma int}$ )

If source is set to "off", all subsequent traces are of no significance (menu jumps to start trigger).



## 4.7 Configuring the Energy Meter Mode/Low Tariff

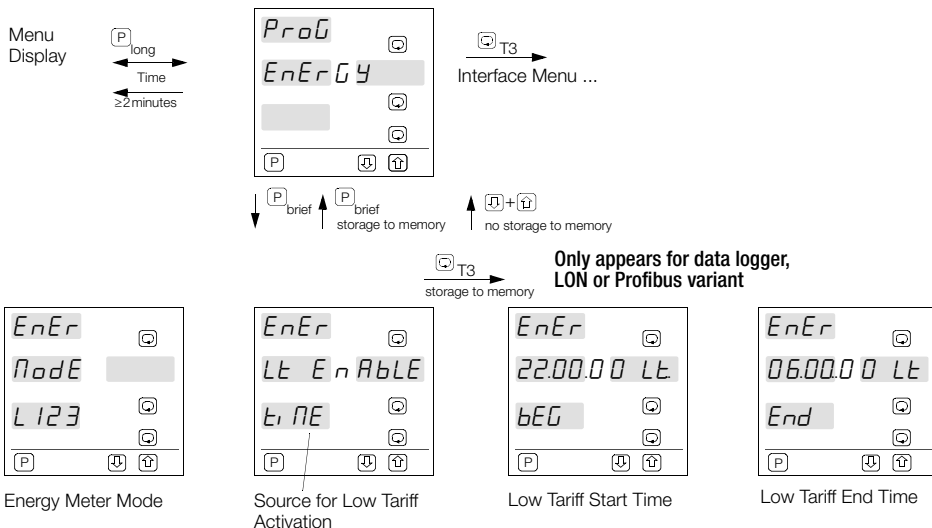

**J I** : Mode setting  
**L123** = Individual phases  
**LtHt** = Low tariff high tariff (import / export)  
 Active and reactive energy

This setting only refers to the energy meters and not to the pulse outputs. After switch-over it is advisable to delete the meter readings, see chapter 4.9 on page 36.

**J I** : Source setting  
**LnE** = Internal clock with data logger.  
**noLt** = Variant without data logger does not provide for low tariff function via clock.  
**EEt** = Switch-over via synchronizing input  
**Lt** = input short-circuited  
**Ht** = input open

Setting same as for clock, see chapter 4.9 on page 36!!  
 (seconds remain at zero)

If only high tariff is requested, select the same value for start time and end time.

## 4.8 Interface Configuration

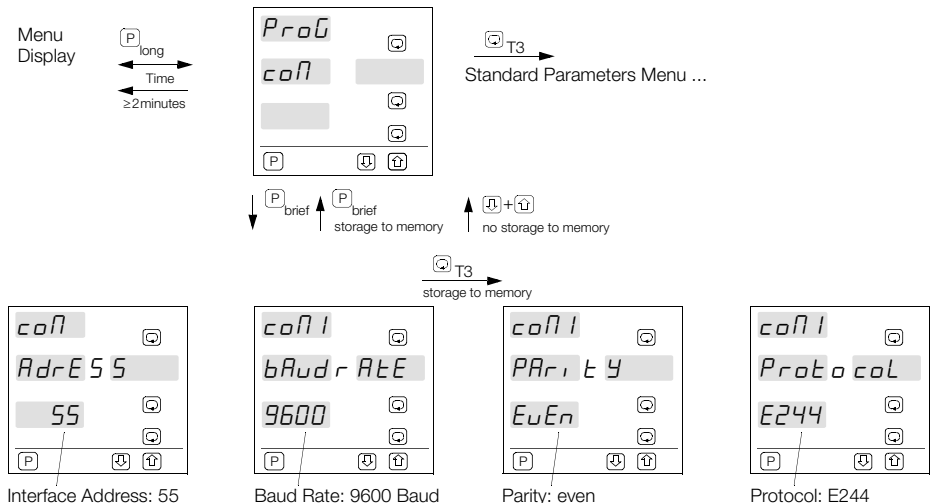

Interface Address: 55

Baud Rate: 9600 Baud

Parity: even

Protocol: E244

U+U: Value Settings

0 ... 254

(for variants with Profibus-DP: all addresses > 126 are interpreted as initialization address 126!)

U+U: Value Settings

1200, 2400, 4800,  
9600, 19.20k

U+U: Value Settings

*EuEn* = even  
*odd* = odd  
*SPcE* = space  
*no* = no

U+U: Configuring the Communications Protocol

*E244* = DIN draft  
19244  
*B70* = EN 60870  
*Mod1* = Modbus  
new version  
*Mod2* = Modbus  
previous version

These values apply to both the RS485 and the RS232. However, both interfaces cannot be operated simultaneously.

Only appears for LON interface variant:

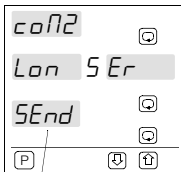

LON service, only if key is pressed and held

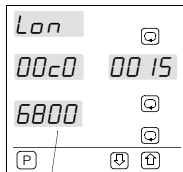

LON ID: 00c000156800

T3 →  
storage to memory

Only appears for Profibus DP variant:

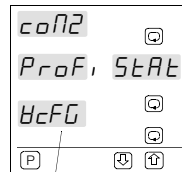

Status: Wait Config

⏏ ⏏ : LON service

⏏ ⏏ : Status:

HcFG = Wait Config  
 HPRr = Wait Parameter  
 dREr = Data Exchange  
 Errr = Error

Only one of these two variant options can be installed. The RS-485 interface is omitted for the LON interface variant, and the RS-485 interface with analog outputs is omitted for the Profibus DP variant.

## 4.9 Uploading and Deleting Parameters, Setting the Clock

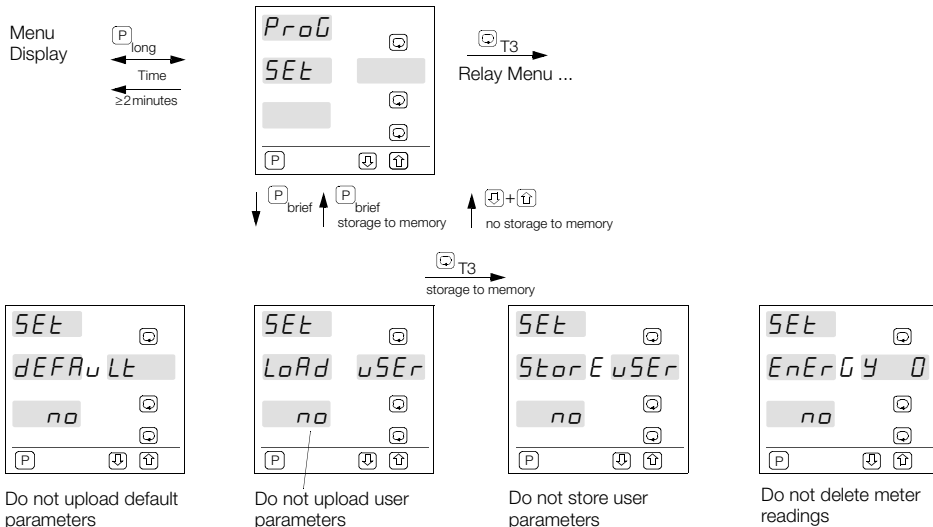

**T** **T**: settings no/yes. For reasons of safety, the **T** or **T** key must be pressed and held for more than 2 sec.

————— yes loads/stores the corresponding parameters —————

————— yes deletes all —————  
meter readings

 T3  
 storage to memory

Only appears for data logger,  
 LON or Profibus variant

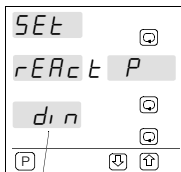

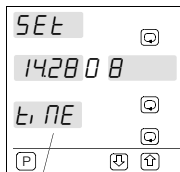

Selection: with or  
 without + or - sign

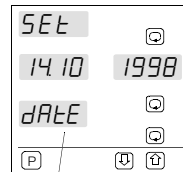

Selection and storage of  
 hours and minutes (corre-  
 sponding display blinks)



Selection and storage of  
 day, month and year

  : Status:

$d_i n$  = Reactive power per DIN 40110  
 without + or - sign

$S_i U_n$  = Reactive power with + or - sign

$C_{o}nP$  = Compensating reactive power

  : Selection:

Adjust hours and  
 minutes (seconds are  
 set to zero when time  
 is saved to memory)

  : Selection:

Adjust day, month  
 and year

## 5 Electrical Connections and Circuits

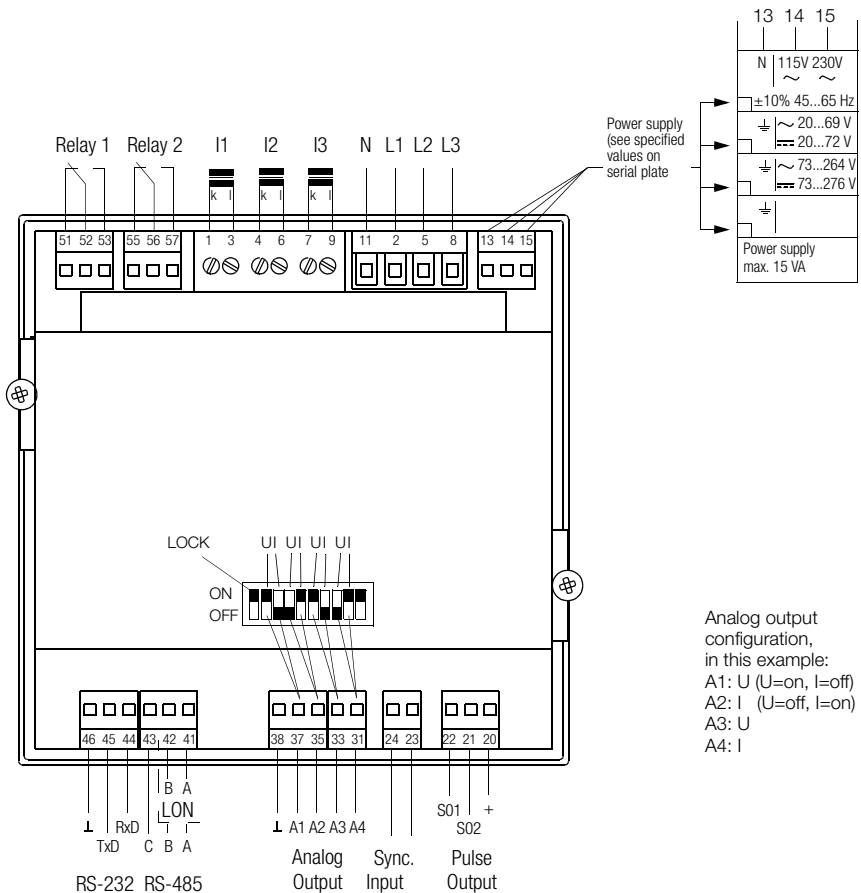

Analog output configuration, in this example:  
 A1: U (U=on, I=off)  
 A2: I (U=off, I=on)  
 A3: U  
 A4: I

## RS-232 Pin Assignments

Sub-D plug at PC		
No. of pins	25	9
DCD	8	1
RxD	3	2
TxD	2	3
DTR	20	4
Gnd	7	5
DSR	6	6
RTS	4	7
CTS	5	8

A2000
RS-232
TxD
RxD
⊥



## RS-485 Pin Assignments (not included with LON variant)

Master
A
B
C



A2000
A
B
C

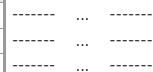

Master
A
B
C

Matching resistor

## Profibus DP connection (optional)

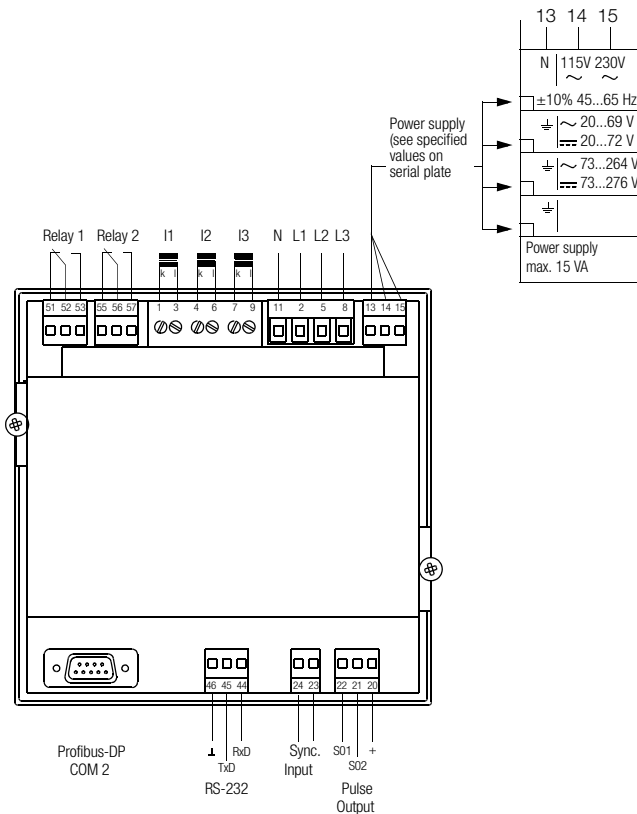



## Electrically Isolated Circuits

Voltage Inputs L1  
L2  
L3  
N

Current Inputs I1  
I2  
I3

Synchronizing Input

Power Supply (per serial plate specs)  
Attention:  
The device is not equipped with an integrated circuit-breaker

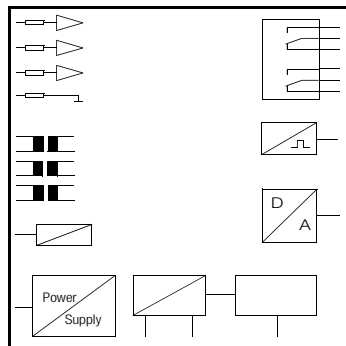

Limit Value Relay 1

Limit Value Relay 2

Pulse Outputs  
S01, S02 (optional)  
common reference point +

Analog Outputs  
A1, A2, (A3, A4 optional)  
common reference point  $\perp$

RS232, RS485  
Interface

LON or  
Profibus-DP-  
Interface  
(optional)

## 6 Interface Description

The following sub-chapters include a brief description of the interfaces.

Please refer to the following manuals if you require a detailed description of the interface protocols:

Communications Protocol per DIN draft 19244

Reference No. 3-349-125-03

Communications Protocol per EN 60870

Reference No. 3-349-128-03

Communications Protocol per Modbus – *Mod 1* –

Reference No. 3-349-225-03

Communications Protocol per Modbus – *Mod 2* –

Reference No. 3-349-129-03

LON Interface

Reference No. 3-349-091-03

Profibus Interface

Reference No. 3-349-092-03

## 6.1 General

The instrument is equipped with an RS232, as well as an RS485 interface as standard equipment. However, only one interface may be operated at any given time. If a LON interface has been installed (optional), the RS485 interface is not included. See chapter 5 on page 38 for electrical connections. If the optional Profibus DP interface has been installed instead of the LON interface, the RS-485 and the analog outputs are omitted. See the Profibus DP interface description for electrical connections.

- Char. format: 8 data bits, 1 parity bit, 1 stop bit

- Parity: even, odd, space, no

The following settings are required in order to fulfill the requirements set forth in the respective standards:

- DIN draft 19244: even, if operated at a modem: no

- EN 60870: even

- Modbus: even, odd, no

## RS-232

Depending upon the driver software, it may be necessary to install jumpers at the master, e.g. DCD+DTR+DSR and RTS+CTS.

## RS-485

If the RS485 interface is used, up to 32 instruments can be interconnected via the bus. In this case, all ABC terminals are connected to one another in parallel. Wiring must be carried out from one instrument to the next; star networks may not be implemented. For bus cables of greater than 5 meters in length, the bus should be terminated at both ends with a surge impedance (e.g. 200  $\Omega$  between A and B).

## 6.2 Communications Protocol

The communications protocol in accordance with DIN draft 19244, EN 60870 or the Modbus protocol is used for communications between the field control and device levels. The A2000 utilizes only a subset of the functions defined in the protocol. Separate descriptions are available for each of the individual communications protocols.

The following functions are not used: query acknowledgement for individual characters and transmission control by means of record sequence bit.

### Time Response Characteristics

Ready to transmit/receive after start-up

$$t_{ber} > 5 \text{ s}$$

Character delay time (A2000 transmitter)

$$t_{zvs} < 3 \text{ ms}$$

Character delay time (Master)

$$t_{zvm} < 100 \text{ ms}$$

Response delay time (A2000 transmitter)

$$10 \text{ ms} < t_{av} < 100 \text{ ms}$$

Query waiting time after response from A2000 (master)

$$t_{aw} > 10 \text{ ms}$$

## 7 Dimensional Drawing

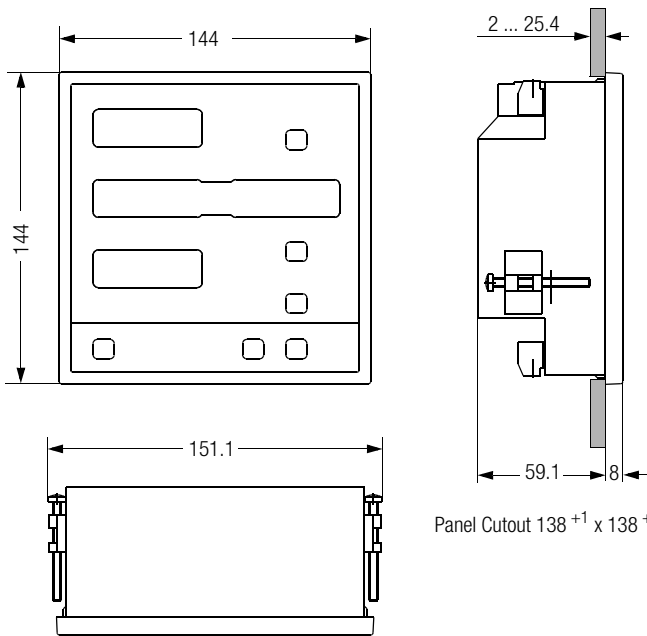

Panel Cutout  $138^{+1} \times 138^{+1}$  mm

All dimensions in mm

## 8 Technical Data

### Measurement Inputs

#### Voltage Inputs

Phase – Phase	0 ... <u>500</u> ... 550 V, 40 ... 70 Hz
Phase – N (ground)	0 ... <u>290</u> ... 320 V, 40 ... 70 Hz

Overload	1.2-fold
Intrinsic Impedance	> 290 k $\Omega$
Power Consumption	< 1,1 W

#### Current Inputs

Overload	0 ... <u>1</u> ... 1.2 A 0 ... <u>5</u> ... 6 A 1.4-fold cont. 30 A / 10 s, 100 A / 3 s
Power Consumption	< 150 mW

#### Sampling Rate

32 samples per period  
per measurement value

#### Measuring Error

Current	NV = nominal value, MV = measurement value $\pm (0.25 \% \text{ of NV} + 1 \text{ digit})$ for $MV > 2 \% \text{ of NV}$
Voltage	$\pm (0.25 \% \text{ of NV} + 1 \text{ digit})$
Power, Energy	$\pm (0.5 \% \text{ of NV} + 1 \text{ digit})$
Power Factor	$\pm 0.02$ for U, I > 10 % of NV
Frequency	$\pm 0.02$ Hz
<b>4-Quadrant Operation</b>	Measurement: import and export, inductive and capacitive

### Interfaces

	RS-232 and RS-485 alternatively: RS-232 and LON or RS-232 and Profibus-DP
Baud Rate	1200, 2400, 4800, 9600, 19200 baud
Parity	even, odd, space, no

Protocol for RS-232 and RS-485	selectable: GMC device bus (DIN draft 19244), EN 60870 or Modbus (RTU)
-----------------------------------	--

### Synchronizing input

On	short-circuited with $R < 10 \Omega$
Off	open with $R > 10 \text{ M}\Omega$

### Pulse Outputs

Contact	open collector
Current	ON 10 mA ... 27 mA OFF < 2 mA
External Voltage	8 ... 30 V
Pulse Duration	selectable 100 ... 800 ms
Interpulse Period	$\geq 10$ ms

### Analog Outputs

Output Quantity	configurable
<b>Current</b>	
Ranges	0 – 20 mA, 4 – 20 mA, $\pm 20$ mA
Load	max. 500 $\Omega$
Load Effect	< 0.8 $\mu\text{A} / \Omega$ (0 ... <u>250</u> ... 500 $\Omega$ )
Resolution	0.1 % of control range
Error Limit	$\pm 0.5 \% \text{ of final value}$
<b>Voltage</b>	
Ranges	0 – 10 V, 2 – 10 V, $\pm 10$ V
Load	< 20 mA
Load Effect	no effect to > 10 k $\Omega$
Resolution	0.1 % of control range
Error Limit	$\pm 1.0 \% \text{ of final value}$

where control range = upper range limit –  
lower range limit, e.g. 1200 W = 1500 W – 300 W  
(freely selectable values)

---

## Relay Outputs

Switching Capacity	~/ = 250 V, 2 A 500 VA / 50 W (nominal load)
Service Life	> 500000 switching cycles

---

## Display

Type	7-Segment LED
Display Color	red
Character Height	13.2 mm

## Display Range

Energy	999999999
Power Factor	1.00
Other Quantities	9999

## Internal Clock

(only in version with datalogger, LON or Profibus)

Accuracy	< 2.5 s/day
Power Supply	lithium cell, life cycle appr. 8 years

---

## Power Supply

Supply Voltage	230 V / 115 V $\sim \pm 10\%$
Feature H0	45 ... 65 Hz
Feature H1	20 ... 69 V $\sim 45...450$ Hz 20 ... 72 V =
Feature H2	73 ... 264 V $\sim 45...450$ Hz 73 ... 276 V =
Feature H3	20 ... 27 V $\sim 45...450$ Hz 20 ... 36 V =

Power Consumption max. 15 VA

The instrument is not equipped with an integrated circuit breaker. Therefore, during installation, care should be taken to ensure that

- the building where the instrument is installed includes a circuit breaker,
- the circuit breaker is positioned in close proximity to the instrument and is easily accessible to the operator,
- it is clearly marked as a circuit breaking device for the instrument.

---

## Electrical Safety

### Variants

IEC 61010-1 /  
EN 61010-1

Protection Class	II
Measuring Category	inputs: III, relays: II
Contamination Level	2
Operating Voltage	300 V $\sim / =$
Test Voltage	measuring inputs: 3.7 kV

### Protection

Front Panel	IP 52
Housing	IP 30
Terminals	IP 20

### Fuses

The supply circuit is protected by an internally soldered fuse.

Feature H0	T160mA/250V
Feature H1	T1A/250V
Feature H2	T250mA/250V
Feature H3	T1.25A/250V

---

## EMC

Interference Emission/ Interference Immunity	IEC 61326 / EN 61326
---	----------------------

---

## Ambient Conditions

Operating Temp.	0 ... 50 °C
Storage Temp.	- 25 ... 70 °C
Relative Humidity	75% no condensation

---

## Housing

Front Dimensions	144 x 144 mm
Panel Cutout	138 <sup>+1</sup> x 138 <sup>+1</sup> mm
Bezel Height	8 mm
Installation Depth	59.1 mm
Weight	1 kg (without packaging)
Mounting	DIN screw clamps
Terminals	screw clamp terminal blocks

## 9 Maintenance – Device Return and Environmentally Sound Disposal

### Maintenance

The A2000 does not require maintenance at regular intervals.

### Device Return and Environmentally Sound Disposal

The A2000 is a category 9 product (monitoring and control instrument) in accordance with ElektroG (German electrical and electronic device law). This device is not subject to the RoHS directive.

We identify our electrical and electronic devices (as of August 2005) in accordance with WEEE 2002/96/EC and ElektroG with the symbol shown to the right per DIN EN 50419.

These devices may not be disposed of with the trash. Please contact our service department regarding the return of old devices (see chapter 9).



## **10 Repair and Replacement Parts Service DKD Calibration Lab and Rental Instrument Service**

When you need service, please contact:

GMC-I Gossen-Metrawatt GmbH  
Service-Center  
Thomas-Mann-Strasse 20  
90471 Nürnberg, Germany  
Phone +49 911 86 02 - 0  
Fax +49 911 86 02 - 2 53  
E-mail [service@gossenmetrawatt.com](mailto:service@gossenmetrawatt.com)

This address is only valid in Germany.  
Please contact our representatives or subsidiaries for service in other countries.

## **11 Product Support**

When you need support, please contact:

GMC-I Gossen-Metrawatt GmbH  
Product Support Hotline  
Phone +49 911 86 02 - 112  
Fax +49 911 86 02 - 709  
E-mail [support@gossenmetrawatt.com](mailto:support@gossenmetrawatt.com)

---

Edited in Germany • Subject to change without notice • A pdf version is available on the internet

**GMC-I**  **GOSSEN METRAWATT**

GMC-I Gossen-Metrawatt GmbH  
Thomas-Mann-Str. 16-20  
90471 Nürnberg • Germany  
Phone +49-(0)-911-8602-0  
Fax +49-(0)-911-8602-669  
E-Mail [info@gossenmetrawatt.com](mailto:info@gossenmetrawatt.com)  
[www.gossenmetrawatt.com](http://www.gossenmetrawatt.com)